

MANZANA CERRADA

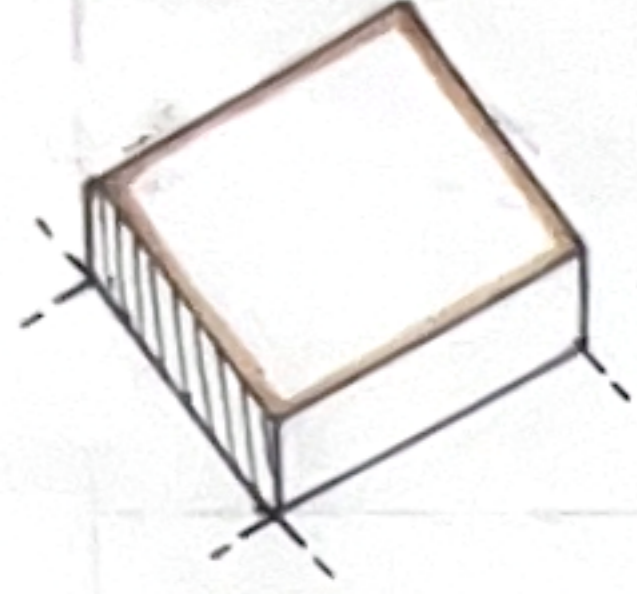

EDIFICACIÓN AISLADA

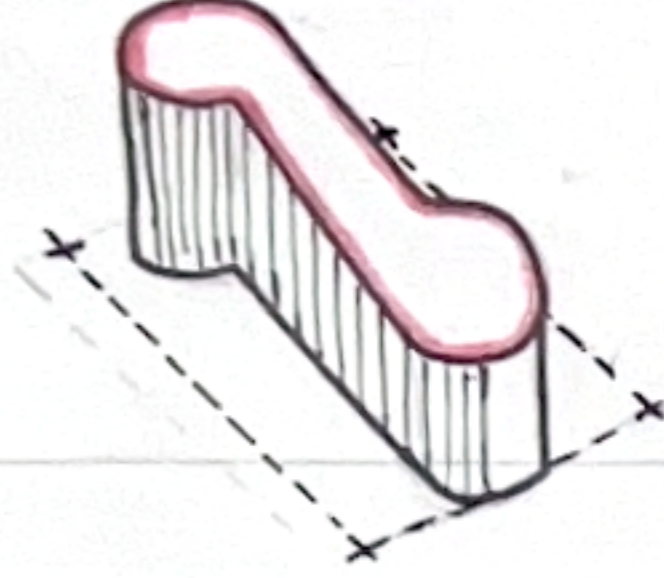

EDIFICACIÓN EN FILERA

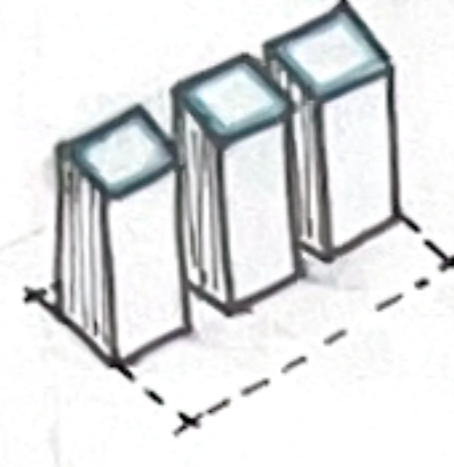

MANZANA CERRADA CON PATIO

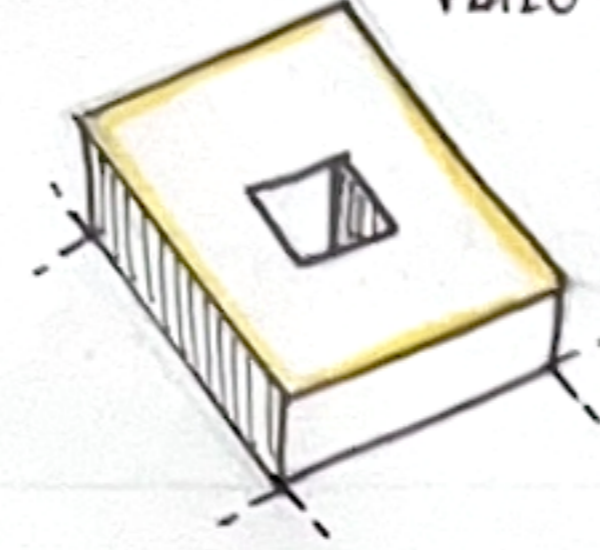

MANZANA ABIERTA SIN PATIO

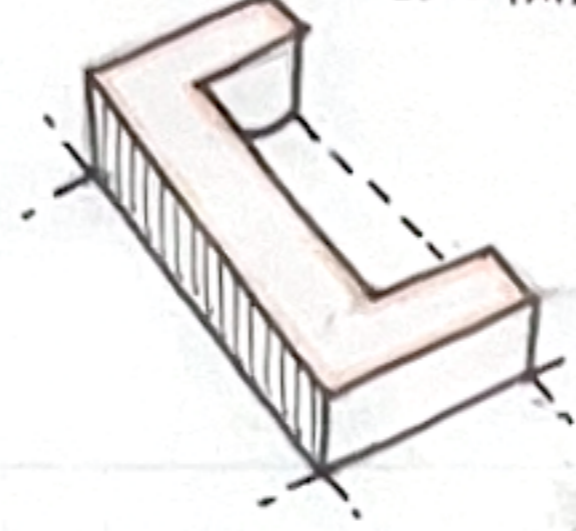

EDIFICACIÓN PAREADA

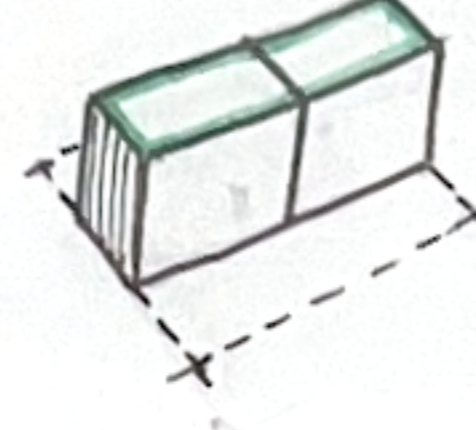

MANZANA ABIERTA CON PATIO

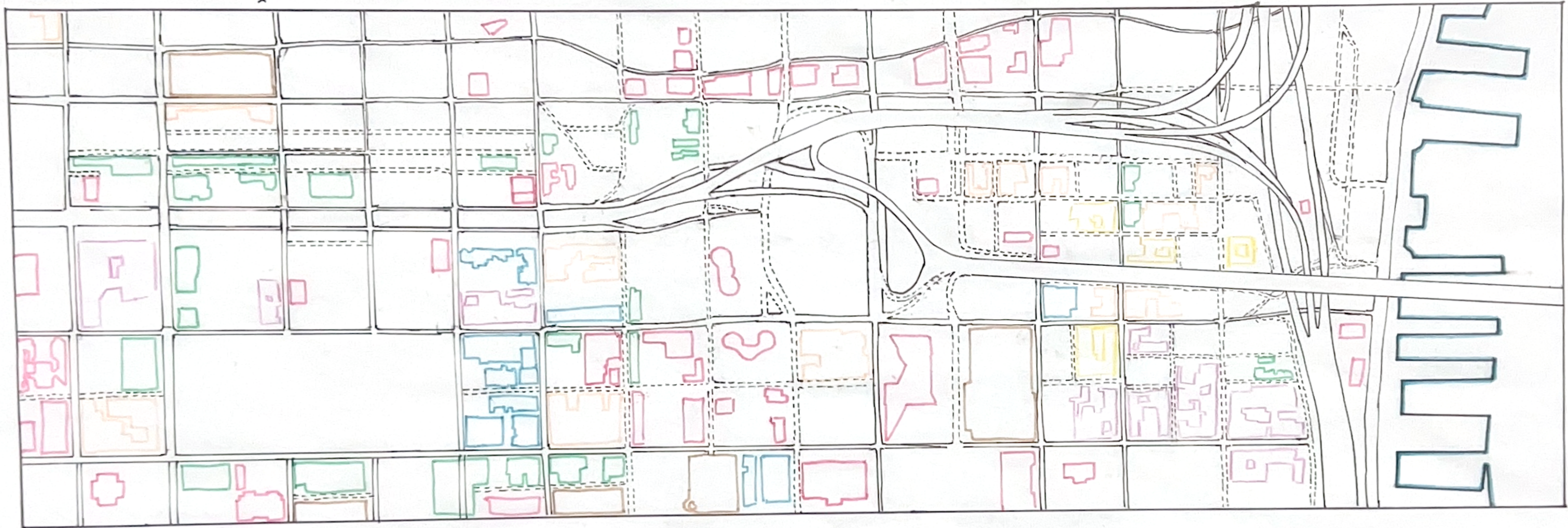
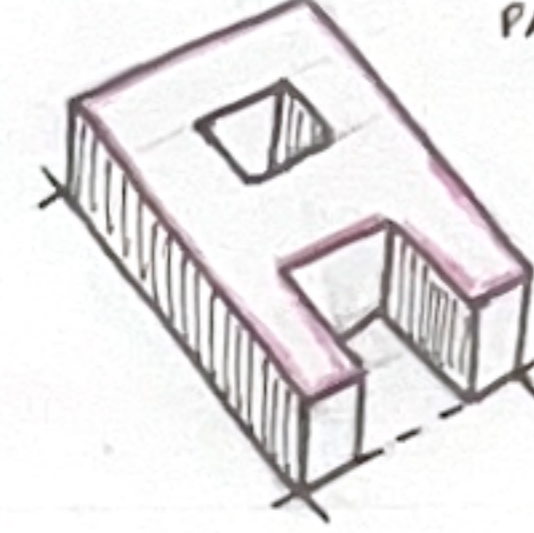

|| CALLES PRINCIPALES

--- CALLES SECUNDARIAS

■ EDIFICACIÓN AISLADA

■ MANZANA CERRADA

■ EDIFICACIÓN PAREADA

■ EDIFICACIÓN EN FILERA

■ MANZANA ABIERTA SIN PATIO

0 150 500

E: 1/5000

